



CONTINUOUS
HIGH SPEED CUTTING



DESIGNED FOR
INDUSTRIAL PRODUCTION



EXTREME
FLEXIBILITY



VERY HIGH
PERFORMANCE RATIO



SPEED UP TO

80

metres/minute

ACCELERATION UP TO

1G

10m/s²



After **more than a decade of experience** with heavy duty cutting in a wide range of industries SMRE introduces SM-330-TA.

The SM-330-TA originates from a symbiosis of superior control systems, very robust machine structure and precision mechanics.

Developed for **continuous high speed cutting** of patterns limited only by the length of the material, the SM-330-TA will streamline your production with **outstanding efficiency and high quality cuts.**

The SM-330-TA is a cutting solution for specialty fabrics and industrial textiles **unlike any other** combining a **top speed up to 80 meters/minute**, an **acceleration up to 1G (10m/s²)**, high precision industrial cutting tools and specifically developed software.

APPLICATIONS

Uncompromising **quality**
professional products

The SM-330-TA enables manufacturers in a wide range of industries to cut patterns of superior quality from an infinite range of fabrics and materials.

Whether you produce

- Tensile structures
- Truck covers
- Swimming pool covers
- Pergolas
- Shade sails
- Pvc tunnels
- Tents and shelters
- Tarpaulins
- Inflatable products
- Conveyor belts
- Containment bladders
- Industrial doors
- Wind breaker barriers
- Sails
- Composite materials products

The SM-330-TA cuts and marks with uncompromising quality.

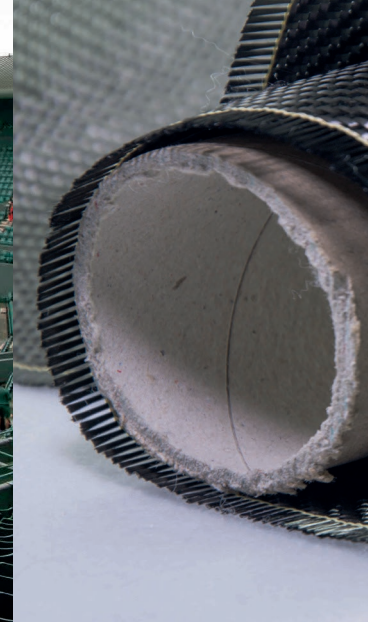

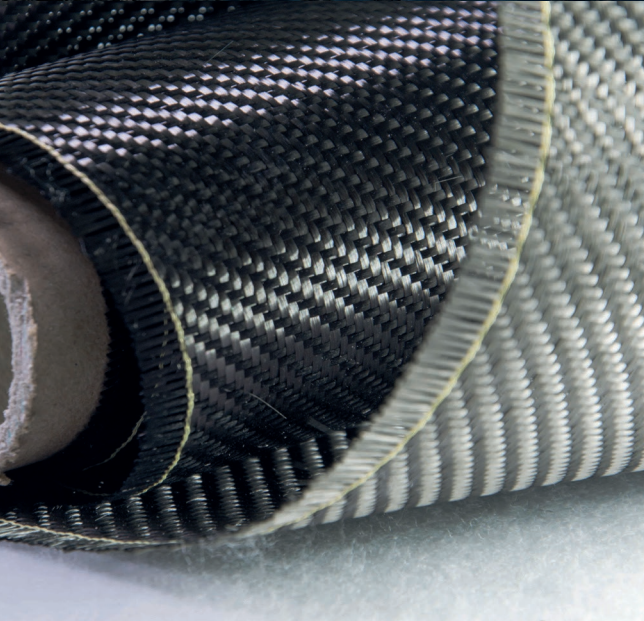

NEW

SM-330-TA



Digital cutting plotter with conveyor belt

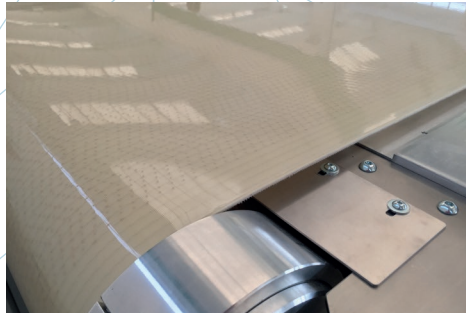

Conveyor belt with extended life span

The conveyor belt is constructed with multi-layer polyurethane with micro perforation to guarantee a highly efficient and constant vacuum suction. Extremely robust and durable it is designed for heavy duty cutting and punching jobs.



Onboard **multi-tools**

Multiple tools and accessories for processing a wide variety of fabrics and materials can be fitted.

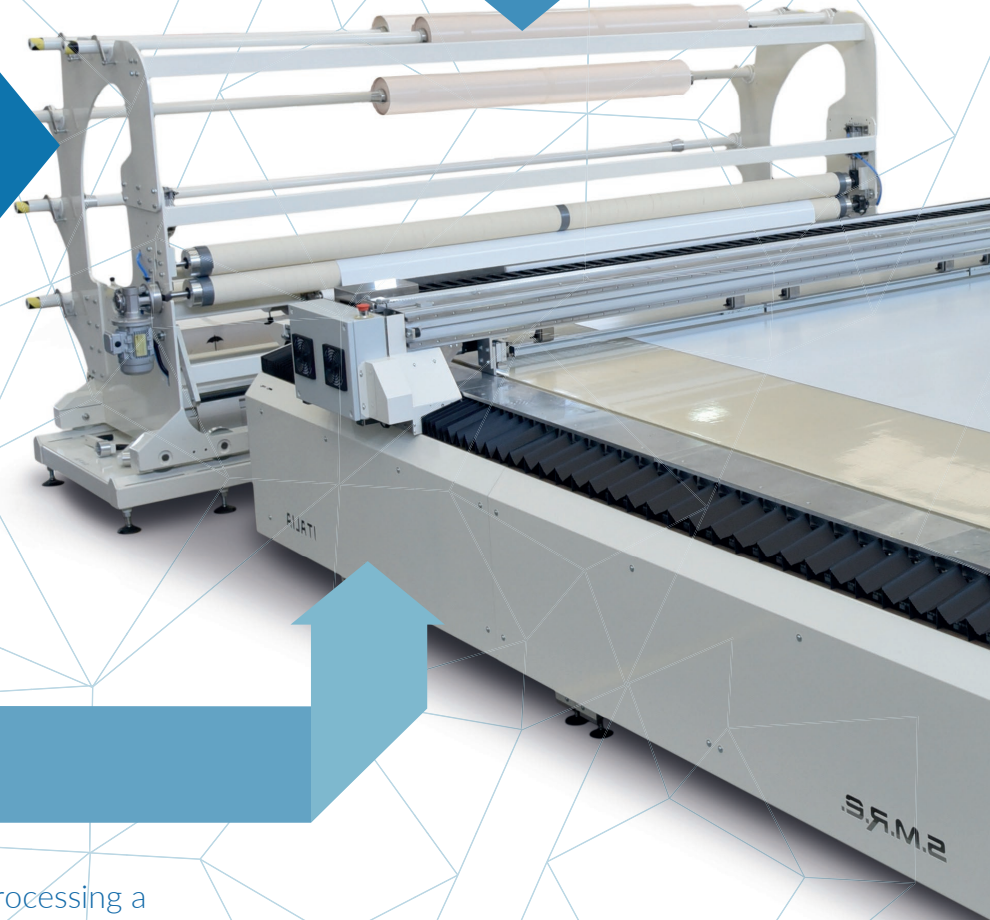

High **speed**, high **precision cutting** and **marking**

Its brushless servomotors, its recirculating ball screw transmission in the tool head and its industrial cutting, punching and marking tools guarantee great precision and high operating speed.

Extremely robust machine structure

The SM-330-TA features a sturdy aluminum monoblock structure and a robust multi-layer conveyor belt. All the components and parts are designed for a heavy duty use.

THE RIGHT SOLUTION FOR YOUR MARKET

Designed to handle **heavy jumbo rolls**

Up to 6 standard rolls and one jumbo roll can be handled by the automatic unwinding system. The sturdy structure of the roll holders and the powerful servomotor are designed to bear heavy weights and to feed automatically heavy fabrics to the machine.

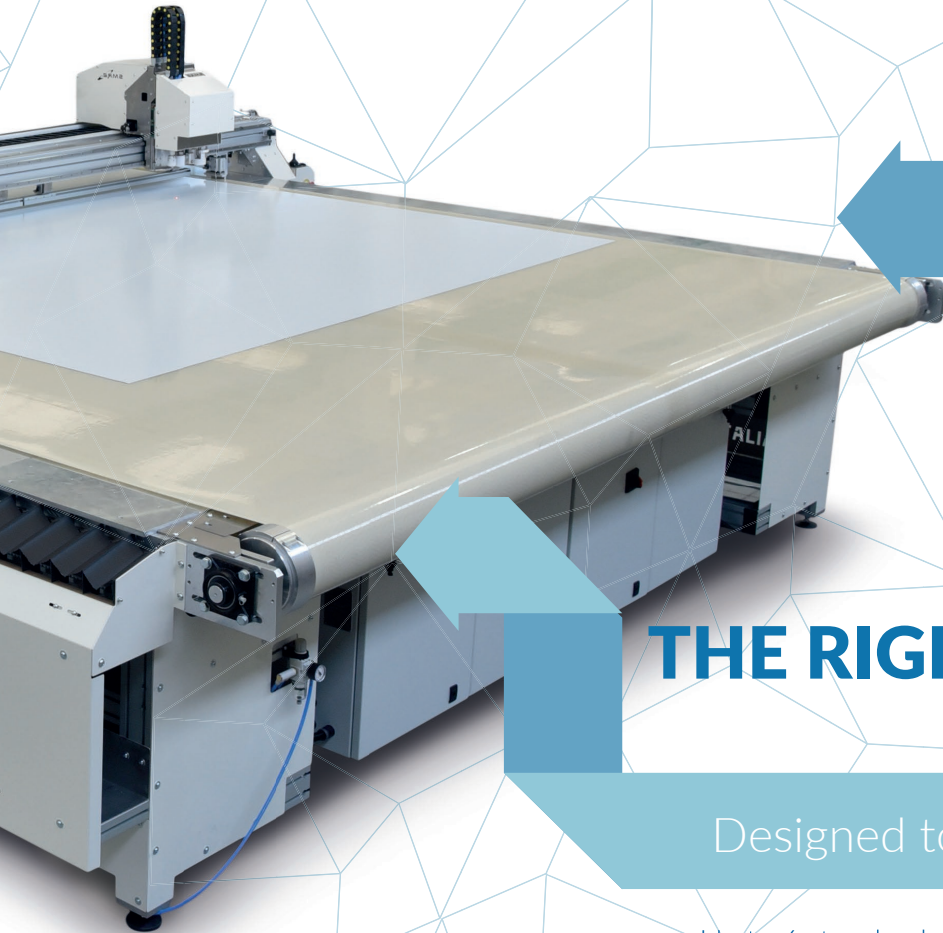

INDUSTRIAL PRECISION TOOLS

The SM-330-TA supports a wide selection of industrial cutting tools that can be installed in a variety of combinations, providing an enormous versatility of applications.

Drag knife. Allows for high cutting speeds on a great variety of materials and fabrics. Ideal for straight cuts, curves, complex shapes and holes with small diameters.

Rotary blade. Diameters, extension of the blade and cutting pressure vary according to your production requirements and the cut material. Suitable for carbon and glass fiber.

Motorized rotating punching tool. Can process heavy fabrics and materials like industrial conveyor belts and heavy PVC.

Laser pointer for the dynamic zero point. Allows the operator to choose a new ZERO point by moving a laser dot over the cutting frame. Ideal for natural materials and when the quality is not the same everywhere.

Marker pen. Holds a marker (ballpoint, felt pen, etc.) to draw lines, curves, circles but also complex shapes, letters and numbers.

Ink jet marking tool. It is faster and more precise than a standard pen marker. It is the ideal solution for the mass production. Suitable for an endless range of fabrics and materials.

Motorized unwinding system. Hold up to 6 rolls and 1 jumbo roll at the same time. Reads the exact position of the fabric. Ensures a very smooth fabric feed.

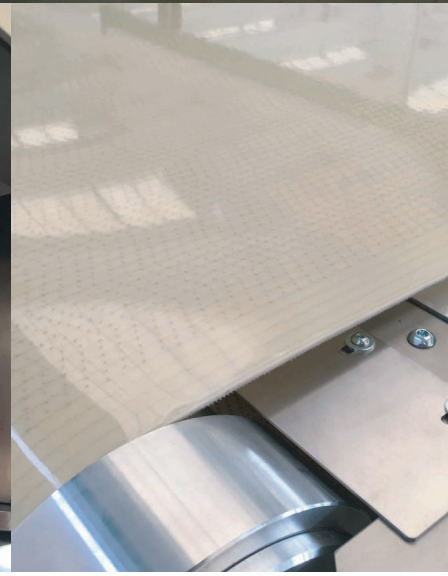

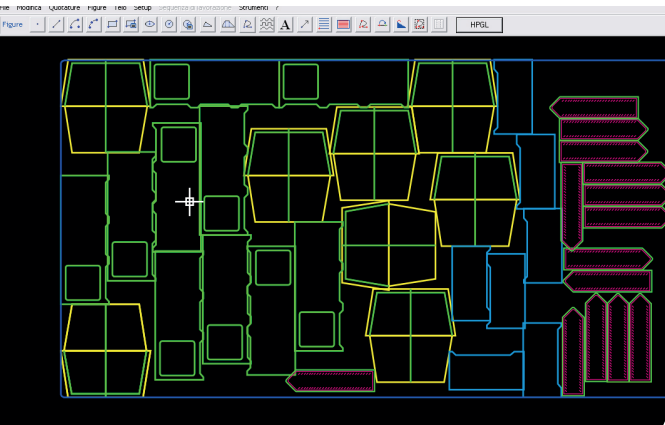
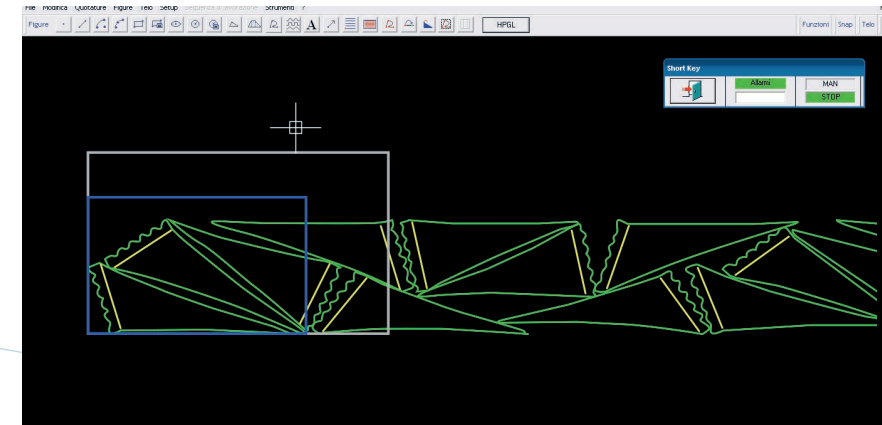

The SM-330-TA installs a series of software modules that turn this machine into a highly efficient digital cutting and marking station with remarkable productivity.

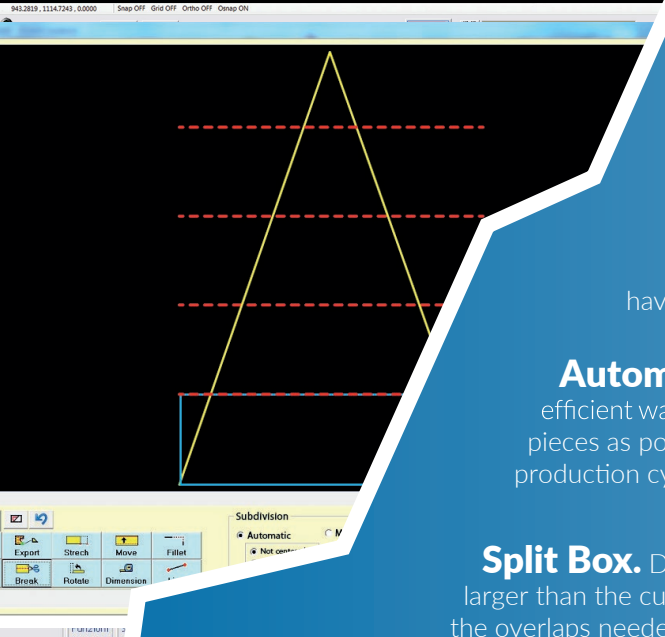
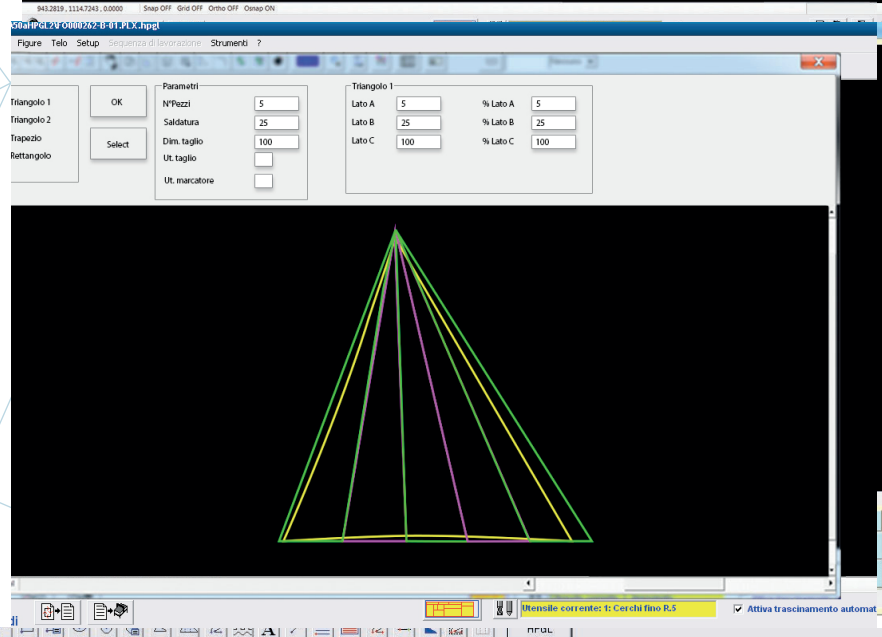

Easy Works Xtreme CAD/CAM.

Calculates the most efficient way of cutting one pattern after the next and saves the optimal settings for every cutting job, including the most suitable tool, the optimal acceleration and the maximum speed, a feature that makes it very easy to repeat a job without having to reprogram the machine.

Automatic nesting.

Automatically calculates the most efficient way to fit the shapes on the cutting frame and cut as many pieces as possible out of the available material. Nesting optimizes the production cycle in terms of speed and use of material.

Split Box.

Designed to manage the creation of patterns that are larger than the cutting frame or wider than the roll, automatically calculates the overlaps needed for the bonding of the fabric in a subsequent step in the production cycle. Makes calculations that would otherwise take a great deal of time and require the intervention of an expert designer.

Macros.

Enable the operator to program highly complex cutting jobs by entering a limited number of key parameters. Macros are often custom made and greatly simplify the production cycle and save a lot of time.

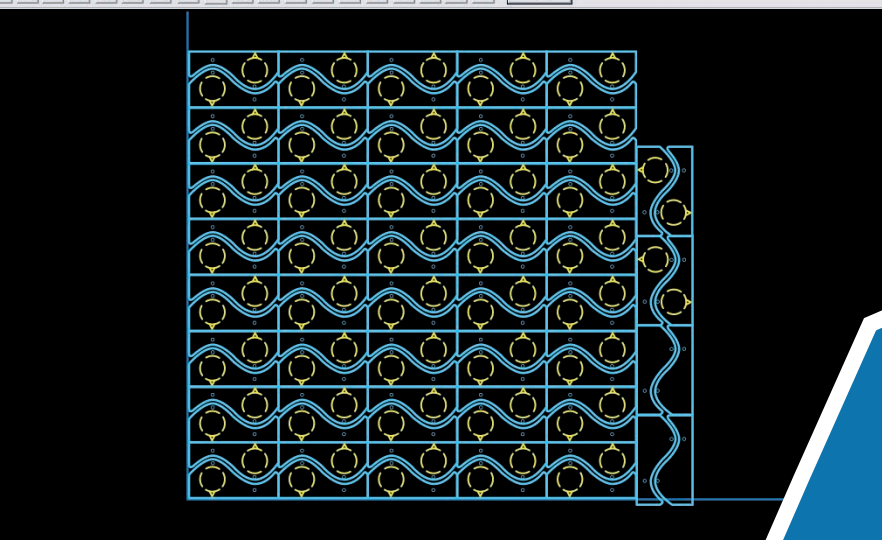

SOFTWARE

Available usable dimension - YxX 2x3/3,2x2/3,2x3/3,2x5/5x3

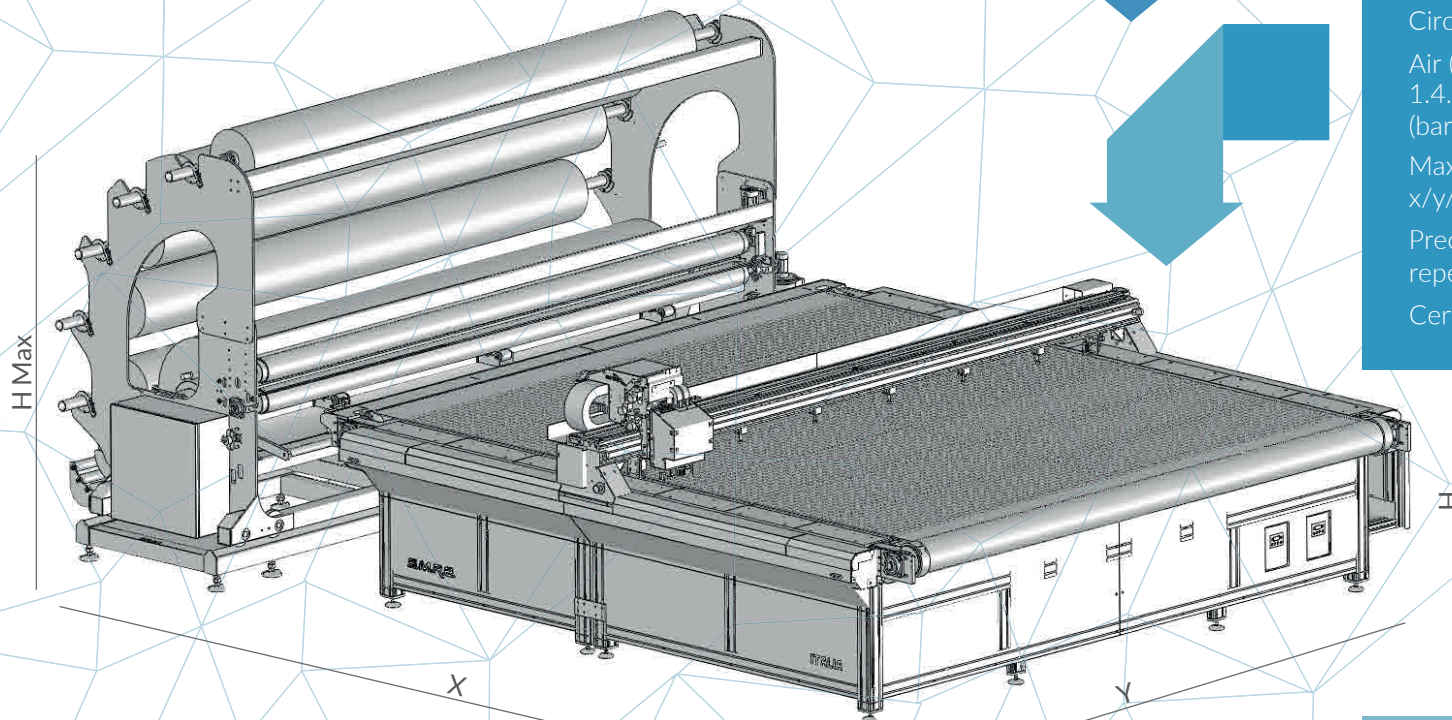

SM-330-TA

Digital cutting plotter with conveyor belt

	Machine (3,2 x 3,0 m)	Unwinder
Power (KW)	20	1,9
Voltage (V)	400 (3 phases+N+E)	220 (1 phase)
Circuit breaker (mA)	300	300
Air (Quality class 1.4.2 ISO 8573) (bar)	6	6
Max. axes speed x/y/z (m/min)	80/80/15	-
Precision axes repeatability (mm)	0,1	-
Certification	2006/42/EC; 2014/30/EU; EN ISO 12100	

Footprint	Machine (3,2 x 3,0 m)	Unwinder
X (mm)	4250	1450
Y (mm)	4400	4500
H (mm)	950	1950
H MAX (mm)	1600	1950
Weight (Kg)	2950	1900

Images and technical features in this catalogue may differ from the actual product. Some of the images may show machines equipped with optional components, tools and/or accessories. SMRE SpA reserves the right to change or modify the product without any prior notice



SMRE THE GLOBAL MANUFACTURING SOLUTION

Founded in 1999 by Samuele Mazzini, SMRE S.p.a. is a **globally operating** company based in **Italy** specialized in the **design and construction** of industrial manufacturing solutions.

SMRE builds **cutting, welding, and sewing machines**, and **special, custom-made solutions** that **streamline** our customers' manufacturing processes, **optimize** their **efficiency**, and increase the **quality** and **output** of their production.

More than **1000 manufacturing** solutions provided to customers in **40 nations** and **6 continents** secure our positions as **leading supplier of industrial machines**.

SMRE is quoted in **AIM Italia** since April 2016



**CUTTING
MACHINES**



**WELDING
MACHINES**



**SEWING
MACHINES**



**SPECIAL
MACHINES**



**SOFTWARE
SOLUTION**

INDUSTRIAL GROUP

1

USA BRANCH

1

MANUFACTURING
PLANTS

2

CUSTOMERS IN 40 NATIONS
ON 6 CONTINENTS

40
6

SPECIALIZED
BUSINESS UNITS

3

INTERNATIONAL
PARTNERS

13

PRODUCT LINES

5

HIGHLY SKILLED
EMPLOYEES

65

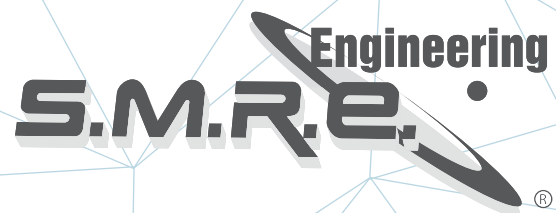

P.Iva e C.F.: 02739550545 - R.E.A. PG Nr. 237823
Capitale sociale: € 1.924.890,00 I.V.
Piazza Antonio Meucci, 1 Loc. Montecastelli
06019 Umbertide (PG) Italy
Tel. +39 075 930 65 00 - Fax +39 075 930 65 37
info@smre.it - www.smre.it

